



# HYDROVOS

Reverse Osmosis System

Installation and Operation Manual

HV-RO1600-OD

HV-RO1400-OD

# Contents

02	Table of Contents	14	Troubleshooting
03	Product & Accessories	15	Specifications
	What's in the Box	16	Warranty Card
04	Precautions	17	1 Year Limited Warranty Terms
05	Installation Diagram	18	Filter Change Record
06	Recommended Filter Replacement Interval		
07	Installing the RO		
10	Startup Instructions & Display		
11	Display Function & Filter Replacement		
12	Filter Replacement		
13	Daily Maintenance		

# To HYDROVOS Users

Thank you for selecting the HYDROVOS Tankless Reverse Osmosis System.

Check to ensure that the serial number on the exterior box matches with the number on your RO unit, your manual, and your warranty card. It is an important proof of identity for your authentic HYDROVOS product and can be used to obtain support.

Carefully read this manual in its entirety before attempting installation. Keep this manual in a safe place.

For more product information, scan the QR code to the right and choose either the HV-1400-OD or the HV-RO1600-OD. Information on how to purchase replacement filters is available through our website at [www.hydrovos.com](http://www.hydrovos.com).



Official Website: <https://www.hydrovos.com>

# Products & Accessories

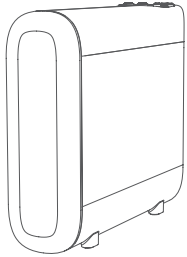

Main RO  
Unit x 1



Filter #1 - PRE/POST filter  
HV-RO1-PRE/POST



Filter #2 - RO Membrane  
HV-RO1400-ROM or HV-RO1600-ROM

## Preparations Prior to Installation

Please confirm all accessories in the packing box are intact before installation.

1. Unpack and take out the RO system and parts kit.
2. Check the back of the RO system, the packing box and the warranty sheet for consistency of the serial number.
3. Confirm the installation site and space for the RO system, and ensure 110v 2-prong outlet is available for use.

## What's in the Box:



User Manual x1

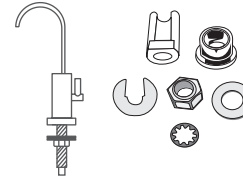

Faucet x1

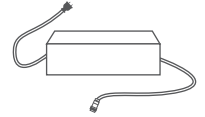

Power Adapter x1  
120V/60

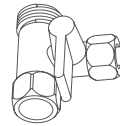

Inlet Three-way  
Ball Valve x1



Faucet  
Connector



1/4 Clips  
x3



3/8" Clips  
x3

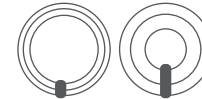

White 3/8" PE Tubing x1  
Red 1/4" PE Tubing x1  
White 1/4" PE Tubing x1  
Black 3/8" PE Tubing x1

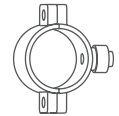

Drain Clamp  
x1

# Precautions

## Installation Considerations

- ◆ This RO system requires feedwater turbidity of less than 10NTU. If your feedwater does not meet this standard, use of a sediment prefilter is recommended.
- ◆ This RO system requires a feed water pressure between 15-60 PSI. Install a pressure booster or regulator as required if the feed water pressure does not meet this requirement.
- ◆ This RO system requires a feed water temperature between 40°F to 100°F. Do not install on a hot water line.
- ◆ If feed water temperature drops below 40°F, close the inlet tee and open the faucet for 1 min, so that water inside the RO system is discharged. Unplug RO system. Once feed water reaches 40°F or higher you can return to normal operation.
- ◆ Use of components other than those supplied with this system will void your warranty.
- ◆ Follow these instructions for installation and operation.
- ◆ Replace filters according to manufacturers recommended frequency.
- ◆ When replacing filters, disconnect the power supply and close the inlet valve.
- ◆ Use only a clean damp cloth to clean your RO system. Do not use harsh chemicals or cleansers as they can damage the surface of the unit.
- ◆ Do not install the RO system in direct sunlight or outdoors.

## Safety Warnings

- ◆ This is a pump driven RO system. Slight vibration and noise during operation is normal.
- ◆ Follow installation instructions. If needed, HYDROVOS recommends installation by a licensed plumbing professional.
- ◆ The power supply should be installed on the wall of the cabinet. Do not place power supply flat on the bottom of cabinet.
- ◆ Do not use damaged power supplies or plugs, or loose sockets.
- ◆ If the power cord is damaged, contact HYDROVOS. Do NOT use RO system.
- ◆ Do not touch the power plug with wet hands.
- ◆ Do not use under high water pressure conditions.
- ◆ Do not store flammable, explosive, volatile, or strong magnetic substances near the RO System.
- ◆ Do not open RO system housing cover. This will void warranty and poses risk of shock.
- ◆ New hose assembly that comes with the RO Unit, old hose assembly must not be reused.
- ◆ Cleaning and maintenance should only be done by adults.
- ◆ The appliance is only to be used with the power supply unit provided.
- ◆ Use only included tubing to install this RO system.

# Installation Diagram

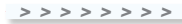
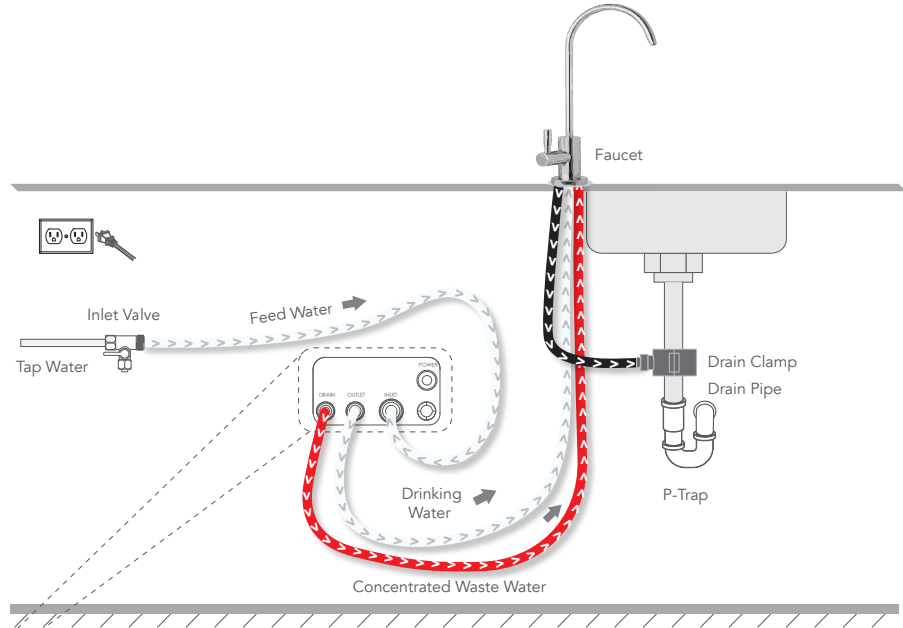
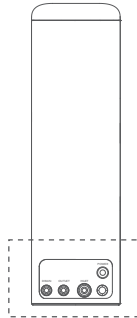
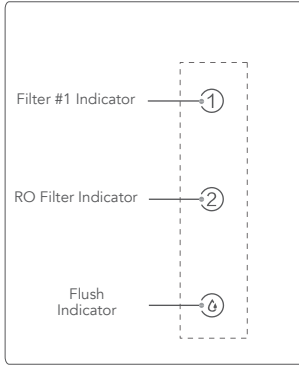

White Tubing for Feed Water and Drinking Water



Red Tubing for Waste Water



Black Tubing for Drain Water

❗ The diagram is for reference only.

# Recommended Filter Replacement Intervals



①



②

Filter	Description	Functions	Interval of Replacement
①	Encapsulated PP+Carbon Composite Filter	Effective removal of sand, rust, suspended substances, residual chlorine, odor and others from the water; the carbon effectively improves the taste and absorbs color and odor from the water.	6-12 Months
②	Encapsulated RO Membrane Filter (RO)	Reduces dissolved solids and potential impurities.	24-36 Months

① Recommended intervals are estimated. Actual service life may differ due to variation in regional water quality, water temperature, usage and other factors.

# Installing the RO

## Install the Inlet Three-way Ball Valve

Install the inlet three-way ball valve and connect the 3/8" white PE tubing to the inlet three-way ball valve.

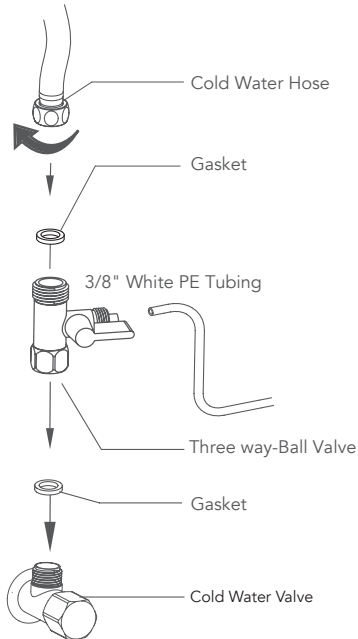

**i** Make sure to switch off the water supply before installation.

## Install the Drain Clamp

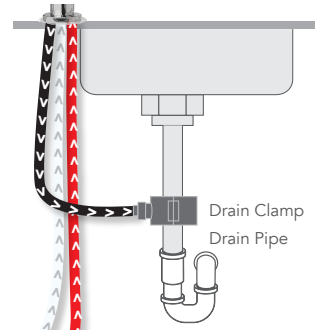

**i** Caution - Do not install before garbage disposal if present. Must be installed on a vertical pipe after garbage disposal. If installing in a two-drain sink, install on side opposite garbage disposal.

1. Decide where drain clamp is to be installed and drill a 3/8" hole in only one side of the vertical drain pipe.
2. Remove paper from adhesive side of drain saddle gasket and apply to the inside surface of drain saddle so that the hole in the gasket is aligned with the hole in the drain saddle.
3. Using a small rod or thin screwdriver center drain saddle hole over hole in drain pipe.
4. Place opposite side of drain saddle on the back side of the drain pipe so that the parts are aligned and use stainless steel bolts to tighten drain saddle parts together.

# Installing the RO (cont)

## Install the faucet

1. If your sink has a third hole for a soap dispenser or sprayer, this hole may be used to install the faucet. If there is no unused hole, one must be drilled into the sink top or otherwise provided. Consult a professional if needed.

2. HYDROVOS RO systems are equipped with an air-gap faucet. Hole size required to fit air-gap module is 7/8". Insert air-gap module through decorative escutcheon plate and pass through 7/8" hole. Place SS plate with cutout on bottom of sink so barbs are within cutout. Place white spacer with cutout facing up onto threaded rod on faucet. Push all the way up. Place SS washer, star washer and nut onto threaded rod and tighten until secure.

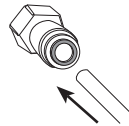
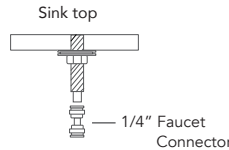
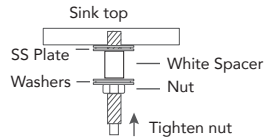

3. Install 1/4" faucet connector to bottom of threaded rod on faucet. Hand tighten only. Take care not to cross thread.

4. Insert the 1/4" white polyethylene tubing firmly into 1/4" quick connector.

5. Once the 1/4" polyethylene tubing is seated into the fitting, lightly tug tubing to create a space between the collet and the fitting. Insert tubing clip into the space created.

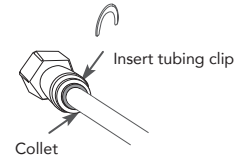

(In the event that you need to remove the tubing from the fitting, first remove the clip, then press the collet down against the fitting face and pull the tubing out.)

**When cutting tubing, make only 90° cuts. Never cut it at an angle. Angled cuts will leak.**

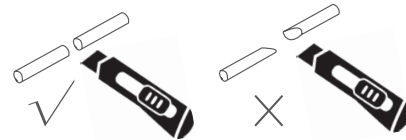



## Installing the RO (cont)

### Connect the Tubing (according to the Installation Diagram on page 3)

1. Connect white 3/8" tubing from 3-way ball valve to the port on the top of the RO system labeled INLET.
2. Connect white 1/4" tubing from the faucet to the port on the top of the RO system labeled OUTLET.
3. Connect 1/4" red tubing to the port on the top of the RO system labeled DRAIN.

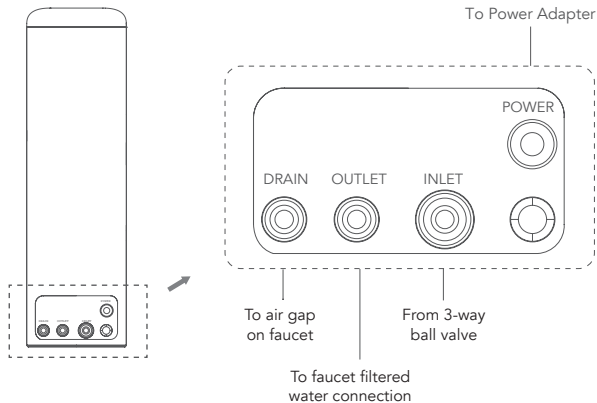

### Initial Filter Installation

1. Align ▲ with unlock icon and insert filter #1 into top hole.
2. Turn filter clockwise, until the ▲ sign is aligned with the lock .

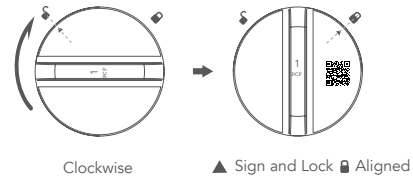

3. Install filter #2 ROM in the same manner



## Startup Instructions

### First Use

1. Open the inlet three-way ball valve and then plug in the power supply.

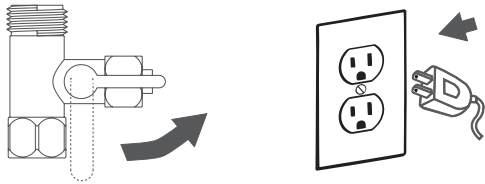

2. Open faucet and observe water flow. When filter is newly installed, there may be black carbon powder or bubbles which appear. This is normal. Run the water until it is clear.

**i** In order to prolong the life of the RO element, the machine is equipped with two intelligent flushing functions: start-up flush and timed flush. During the flush cycles, you may hear water flowing and operating sounds, which are normal. Note: flushing indicator on front panel will be flashing.

## Display

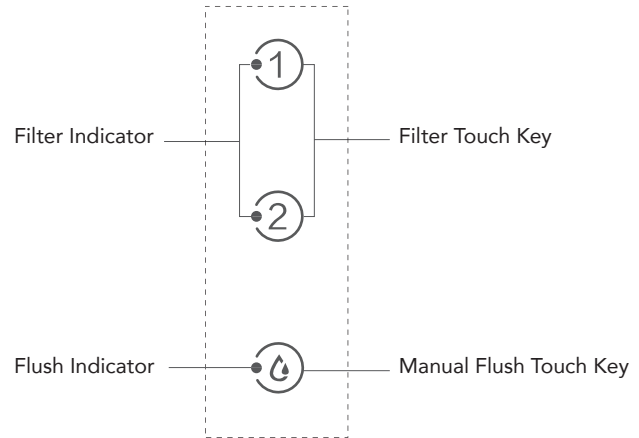

## Display Function Modes

Indicator	Display Mode	Display Description
①	ON	Filter life expired. Replace filter.
	FLASHING	Filter is reaching end of life.
②	OFF	Normal operation.
	FLASHING	System is in flush mode.
③	ON	System is in operation mode.
	OFF	Power supply not connected

## Filter Replacement

1. Close the inlet three-way ball valve.

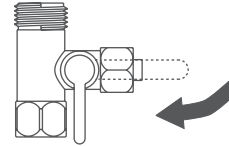

2. Disconnect power supply.

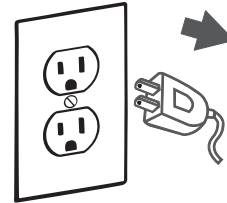

# Filter Replacement

3. Turn filter counterclockwise until ▲ lines up with unlock icon and remove it.

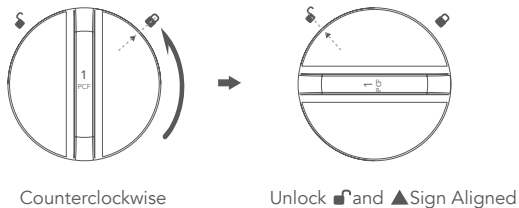

4. Insert and turn new filter clockwise, until ▲ is aligned with the lock icon.

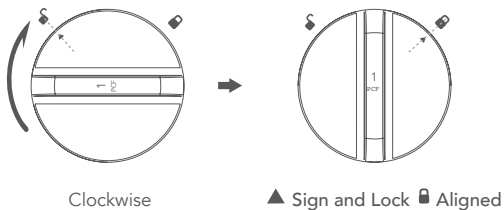

5. Reset filter indicator.

Press and hold relevant filter indicator for 3 seconds until you hear a beep, and the light turns off.



Press and hold for 3 seconds

6. Open the faucet to flush new filter element.

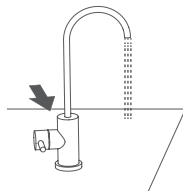

When initially flushing the water after starting RO system, fine carbon powder or bubbles may appear which is normal. It may take 30 seconds or more until the water runs clear.

### Cleaning your Hydrovos RO System

1. Please wipe with soft, clean cloth.
2. For stubborn dirt or dust, using a soft cloth slightly dipped in warm water, gently wipe the system down.
3. When cleaning the outside of the system, use only clean water. Do not wipe the machine surface with harsh liquids or chemicals, such as ethanol, gasoline, paint thinner or other materials.

### Long-term Shutdown of RO System

1. Close the inlet three-way ball valve and disconnect the power supply.
2. To restart the system, first replace filter 1,
  - a. Next, open the inlet three-way ball valve and turn on the power supply.
  - b. Start the system.
3. Open the faucet. When initially running the water for the first time after restarting RO system, fine carbon powder or bubbles may appear, making the water's appear cloudy. This will dissipate after a few moments. Once the water has become clear, turn off the faucet. RO System is now ready for normal use.

 Do not store flammable and explosive substances near the system during operation.

## Troubleshooting

Problem	Causes	Troubleshooting
The RO System fails to start	The power supply is not connected or it is not switched on.	Check whether the power plug is loose or not inserted and whether the power switch is turned on.
	Power adapter malfunction	Check whether the adapter indicator is lit. Replace power adapter.
Water leaking from the RO system	Improper connection of filter or water tubing	Check whether the filters are installed in position and whether water tubing connections become loose.
	Damaged internal component	Promptly disconnect the power supply, close the inlet three-way ball valve and contact HYDROVOS.
No water comes out from the faucet after start-up of the RO system	The cold water valve or three-way ball valve is not opened.	Open the valve.
Abnormally low water flow from the faucet after start-up of the RO system	Bent water tubing	Check the feed water, concentrate and pure water tubing.
	The inlet three-way ball valve is not fully opened.	Check whether the inlet three-way ball valve is fully opened.
	Filter is Blocked	Replace the filter.
Poor quality of treated water	RO Membrane depleted	Replace the RO Membrane.
The RO system fails to stop or repeatedly starts and stops	The faucet is not closed.	Fully close the faucet.

 If the above problems cannot be eliminated, email [info@hydrovos.com](mailto:info@hydrovos.com).

## Specifications

Product Name	HYDROVOS RO System	
Model	HV-RO1600-OD	HV-RO1400-OD
Rated Voltage	120V~	120V~
Rated Frequency	60Hz	60Hz
Water Flow at Faucet	0.4 Gallons/min	0.27 Gallons/min
Feed Water Pressure	15-60 PSI	15-60 PSI
Working Pressure	60-130 PSI	60-130 PSI
Water Temperature	40-100 °F	40-100 °F
Ambient Temperature	35-104 °F	35-104 °F
Feed Water Quality	Municipal Tap Water	Municipal Tap Water
Manufacturer	Hydovos	
Address	PO Box 4761 Mission Viejo, CA 92690	
Dimensions	17.3" x 5.1" x 15.5" (LxWxH)	

# Warranty Card

Dear Customer:

Thank you for choosing HYDROVOS products. We strive to provide you with quality products. This Warranty Card is an important part of your product warranty and encourage you to fill out this card and store it in a safe place. You can also visit our warranty registration page by scanning the QR code below with your mobile phone.

Date of Purchase: \_\_\_\_\_

Product Model: \_\_\_\_\_

Name: \_\_\_\_\_

Product S/N: \_\_\_\_\_

Phone: \_\_\_\_\_

Date of Install: \_\_\_\_\_

Address: \_\_\_\_\_

Purchased From: \_\_\_\_\_



Official Website: <https://www.hydrovos.com>



# 1 Year Limited Warranty

**[HYDROVOS]** warrants to the original purchaser-consumer that its Product is free of defects in materials and workmanship. Any defect, malfunction, or other failure of the Product to conform to this warranty will be remedied by Warrantor in the manner provided below. This Warranty, together with any warranties implied by law, shall be limited to a duration of one (1) year from the original date of purchase by the consumer. This Warranty does not apply to defects that result from abuse, misuse, alteration or damage not caused by HYDROVOS or caused by accident, fire, flood, freezing, Acts of God, misuse, misapplication, neglect, oxidizing agents (such as chlorine, ozone, chloramines and other related components). This Warranty also does not apply to defects, deteriorations or damages that result from installation or use of the Product not in accordance with the specifications provided or caused by uses for which this Product was not expressly intended or by the use of accessories or components which do not meet the Product's specifications.

The Product must be used in operating conditions that conform to Warrantor's recommended design guidelines. This Warranty will not apply if the unit has been modified, repaired or altered by someone not authorized by Warrantor.

THIS WARRANTY IS EXCLUSIVE AND IN LIEU OF ALL OTHER WARRANTIES, EXPRESSED OR IMPLIED, WHETHER ORAL OR ARISING BY USAGE OF TRADE OR COURSE OF DEALING, INCLUDING, WITHOUT LIMITATION, ANY WARRANTIES OF FITNESS OR MERCHANTABILITY. THIS WARRANTY IS THE PURCHASER'S SOLE AND EXCLUSIVE REMEDY.

Refer to the specifications section in the Installation and Operating manual for approved application parameters. THIS WARRANTY DOES NOT COVER, AND IS INTENDED TO EXCLUDE ANY LIABILITY ON THE PART OF WARRANTOR, WHETHER UNDER THIS WARRANTY OR UNDER ANY WARRANTY IMPLIED BY LAW, FOR ANY ANTICIPATED OR LOST PROFITS, INCIDENTAL DAMAGES, SPECIAL DAMAGES, GENERAL DAMAGES, CONSEQUENTIAL DAMAGES, COSTS, TIME CHARGES OR OTHER LOSSES, WHETHER BASED ON BREACH OF CONTRACT, TORTIOUS CONDUCT OR ANY OTHER THEORY, INCURRED IN CONNECTION WITH THE PURCHASE, INSTALLATION, REPAIR OR OPERATION OF THIS PRODUCT.

Warrantor does not authorize anyone to assume for it any liability or to make on its behalf any additional warranties in connection with this Product or any part thereof. Note: Some states prohibit limitations on the duration of implied warranties and on the exclusion of indirect or consequential damages; and so the limitation on implied warranties and on incidental and consequential damages may not be applicable to you.

# Filter Change Record

Filter Number	#1	#2
Date Replaced		
Date Replaced		
Date Replaced		
Date Replaced		
Date Replaced		
Date Replaced		
Date Replaced		
Date Replaced		
Date Replaced		
Date Replaced		
Date Replaced		
Date Replaced		







©2022 HYDROVOS. All rights reserved. | PO Box 4761, Mission Viejo, CA 92690  
Made in Taiwan | Rev 05/22 | Website: <https://www.hydrovos.com> | Toll Free: 833-787-5001

■ This manual may be modified without notice.  
HYDROVOS reserves the right to final interpretation. Rev: V2 20220524